

Nr. ....

## Emissions of Nanoparticles from HDV EURO4 or EURO5 engines compared with EURO3 with and without DPF

**A.Mayer/TTM, M.Kasper und Th.Mosimann /Matter Engineering, F.Legerer/AKPF  
J.Czerwinski/FHS Biel, L.Emmenegger, J.Mohn, A.Ulrich/EMPA, P.Kirchen/ ETH**

Copyright © 2006 SAE International

### Summary

Emissions have been measured in detail on three modern utility vehicles on a chassis-dynamometer, one of the vehicles certified according HDV-engine concept of EURO4 with PM-Kat, the other one according to EURO5 with SCR and these measurements have been compared with those of an EURO3, for both cases, once equipped with DPF and the second time without DPF. The investigation was primarily aimed at solid state nanoparticles in the range of 10-500nm, which are alveolus penetrating. Measuring methods have been SMPS, NanoMet, PASS and ELPI, sampling conforming to PMP; further, emissions of metals by means of ICP-MS were determined as well as secondary emissions inherent in the system especially NO<sub>2</sub> and NH<sub>3</sub>.

For the majority of operating points EURO 4 with PM-Kat and EURO 5 with SCR a moderate reduction of nanoparticle emissions could be observed compared to EURO3 without DPF; however, at full load the EURO 5 engine emitted higher concentrations than a EURO 3 engine without filter. Rather irritating was an erratic stochastic particle release of the by-flow filter of the EURO 4 engine exhibiting a scattering of penetration right to break down very much depending on the loading. Compared to a EURO 3 engine with DPF conforming to VERT criteria both more modern engines emitted 100-500 times more nano-particles. On the other hand, if these engines were equipped with DPF according to the state of the art, emissions compared to EURO 3 without filter would be reduced to 0.1%, i.e. particle concentration of undiluted exhaust would be less than that of the ambient air in traffic exposed locations.

Regarding gaseous emissions the EURO 5 engine exhibited very good results, there were no disadvantageous effects due to the SCR observed, concentrations of NH<sub>3</sub> and N<sub>2</sub>O remained close to the detection limit, while the EURO 4 engine exhibited rather high concentrations of NO<sub>2</sub> at about half load range. Emissions of Vanadium and Platinum were low, even below detection limit.

### Introduction

Solid state particles in the size range from 1 nm to less than 1000nm (= 1µm) are denoted nanoparticles. Particles of this type are observed in IC-engine exhaust in concentrations of 10<sup>7</sup> – 10<sup>8</sup> particles per cm<sup>3</sup>; their respective size range is about 10 - 500 nm, average size is 60 – 80 nm. Particles of this size are alveolus penetrating; having been inhaled they may penetrate cell membranes and find their way into human organs even into the brain within very short time spans. They are regarded as the most dangerous pollutants of the ambient air caused by traffic. In 1989 WHO designated these particles as cancer-generating; one may remark, already in 1775 P. Pott pointed to such an observation. Apart from causing cancer nano-particles may trigger a variety of other health-problems, for instance cardiac infarct, Alzheimer disease, Parkinson [1]. Importance of size has been recognised by researchers and authorities in occupational health already since 1910 [2]. Environmental legislation requires minimisation by means of best available technology. Methods already introduced in 1888 by Aitkin permit to determine concentrations according to number and size with high resolutions. Separation into solid state particles and condensed droplets, characteristic for IC engine exhaust when cooling down, is reliably done by means of the PMP-measuring method evaluated by GRPE [4].

European legislation regarding emissions of IC-engine exhaust introduced limits for emissions of particles for the first time 1992 with EURO 1. Unfortunately, the definition PM10 of US-EPA, dating from 1982, was just copied. As PM10 is a measuring method which does not permit to differentiate according to size or substance, it is not suitable for evaluations with regard to toxicity.

European legislation lacks a limitation of secondary noxious pollutants in contrast to the US Clean Air Act. When introducing new technologies, especially if there are catalytic processes involved in particular in the engine exhaust, generation of poisonous by-products cannot be precluded [5]. Only Switzerland is insisting on a testing procedure when evaluating particle reducing methods, which is based on the number concentration of solids in the nano-range [6] and since 1990 testing for potential secondary emissions is required [7]. DPF-retrofit of con-

struction equipment or of road vehicles is only acceptable for systems satisfying these criteria according to the state of the art.

Meanwhile, European emission criteria have been improved quantitatively, yet not qualitatively; reasoning was, that reducing mass automatically leads to a reduction of numbers – which was not true, it could have been proven mathematically too [27]. Therefore, two representative HDT vehicles certified according to EURO 4 and EURO 5 were selected and compared to a corresponding EURO3 – vehicle with regard to the emission of nano-particles and secondary emissions. Principle question was: Ought there still be a requirement of DPFs, according to VERT standard, even for those engine of extreme low emissions?

### Test-vehicles and parameters for emissions

#### Test-vehicle EURO 3

Make: Mercedes Benz  
 Type: 1846 LS-O3  
 Engine: OM 4001 LA.III/9  
 Nominal Power: 355 kW at 1695 rpm  
 Max torque: 2335 Nm at 1196 rpm  
 Mileage: 49'051 km  
 Emission reduction: Retrofit DPF, make HJS  
 CRT-system, sinter-metal-filter (VERT no. B159/03.05)

#### Test-vehicle EURO 4

Make: MAN  
 Type: TGA 18.430 4XBLS  
 Engine: D 2066LF 11, EURO 4  
 Nominal Power: 316 kW at 1900 rpm  
 Maximum torque: 2212 Nm at 994 rpm  
 Mileage: 31'196 km  
 Emission reduction: EGR cooled, PM-Kat

#### Test-vehicle EURO 5

Make: Mercedes Benz  
 Type: 1896-LS EURO 5  
 Engine: OM 5001 LA.V5  
 Power rating: 348 kW at 1796 rpm  
 Maximum torque: 2221 Nm at 1097 rpm  
 Mileage: 2'863 km  
 Emission reduction: SCR with AD-Blue Technology

#### Fuel.

In trade diesel fuel according SN 181 160-1:2005  
 Sulphur analysis: 10 -15 mg sulphur/kg fuel

EURO 4 and EURO 5 brought about a substantial progress in reduction of emissions compared to EURO 3, PM10 was reduced from 100mg to less than 20mg/kWh within the ESC driving cycle. Engines do not “smoke” any more – however, tailpipes are still blackened by soot. Further, NOx have been reduced tremendously; nevertheless, the any statement on the ratio of NO<sub>2</sub>/NO is still missing.

Our tests of EURO 5 and EURO 3 were carried out at the same time, while due to an extended measuring equipment tests of EURO 4 were done a few months later.

### Test Set-up and Instrumentation

#### Chassis-dynamometer of LARAG AG, Wil

This test bed can be tuned to any stationary operating point of the engines within the whole operating range including accelerating conditions, however dynamic driving cycles are not feasible.

#### Determination of gaseous emissions

EURO 4 and EURO 5: concentrations of CO<sub>2</sub>, CO and NO<sub>2</sub> and NO have been determined by means non-dispersive IR analysis (NDIR) and one two-channel chemo-luminescence analysis (CLD). Volatile organic substances, hydrocarbons, N<sub>2</sub>O, NH<sub>3</sub> SO<sub>2</sub> were determined directly. already in the hot exhaust by means of flame-ionisation spectroscopy (FID) [25], in order to avoid loss of substance due to permeation-drying.

#### Determination of metal-emissions

EURO 5 – vehicle (SCR) was tested for emission of Vanadium (V); EURO 4 (vehicle with PM-Kat) was tested for emissions of Platinum (P). Over the total driving cycle an aliquot proportional to volume of exhaust was absorbed in acid-watery solution, which was finally analysed by means of quadruple plasma-mass spectroscopy (Q-ICP-MS).

#### Particle-analytics

The following measuring methods have been applied:

- SPPS (TSI)
- NanoMet with PAS and DC sensors (Matter Engineering)
- PASS (AVL)
- ELPI (DEKATI)

Sampling was done for SMPS and NanoMet with ME-components according to PMP, sample were heated to 300oC, in order to avoid condensates. FPS dilution was applied in case of PASS and ELPI.

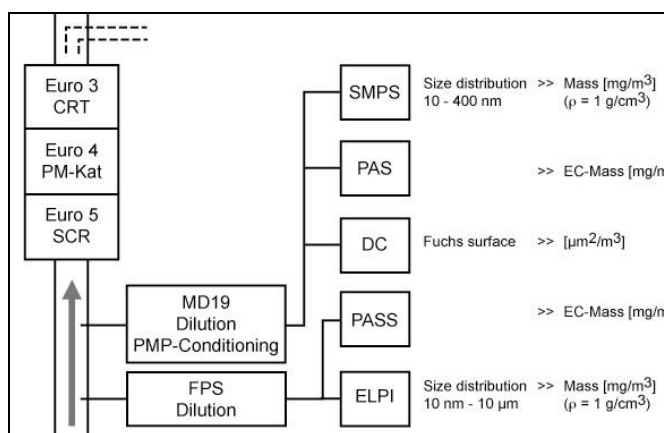

Fig.1a: Schemes for measuring: Particle-analytics

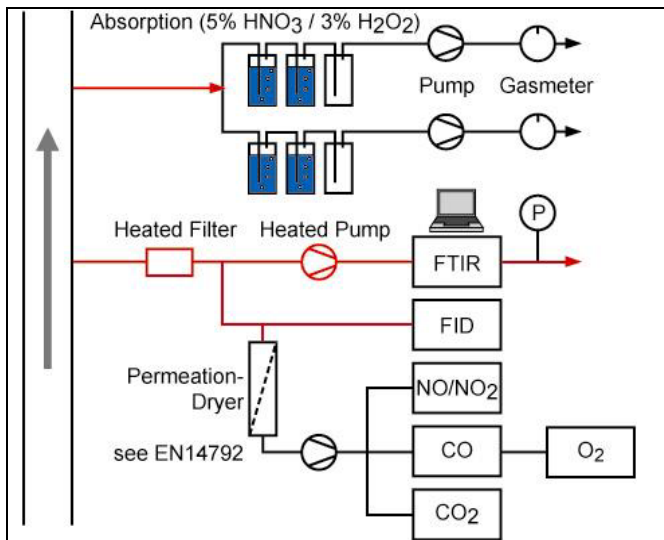

Fig.1b: Gas and metal-analytics

### Operating Points

Measuring points in stationary operation have been selected close to the ESC testing cycle. In the range of low loads graduation was more refined; this way both aims could be served, better understanding of emissions of city-busses and finding more insight of weak points of the systems. Weakness of the SCR System is obviously in the range of very low loads at little activity of the catalyst or when urea injection is completely stopped respectively (~225oC); weakness of the PM-Kat is exhibited if regeneration of the by-flow breaks down due to lack of sufficient NO => NO<sub>2</sub> conversion

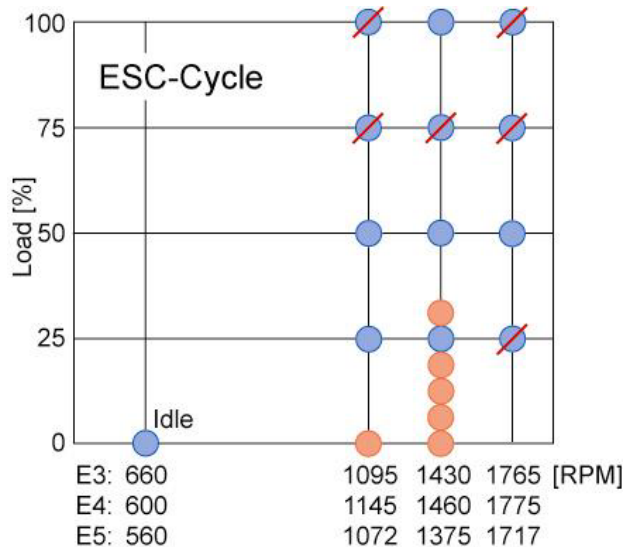

Fig. 2: Operating points oriented on the European Stationary Testcycle ECS.

Crossed out points were cancelled due to excessive tire-abrasion; they were not in the focal interest anyway and their contribution to the overall result is rather low. Operating points marked with red dots have been introduced additionally, to allow a better understanding of behaviour at low loads.

Transient responses were investigated by means of free accelerations from low rpm and low load as well as by means of supplementary loads starting from other operating points.

### Particle emissions under stationary conditions

The following fig. 3 provides size distributions of the four systems investigated at zero-load, at 25% load, at 50% load and at full load, all at 1400 rpm. Decisive for the cycle are the three lower loads; for both EURO 4 and EURO 5 a distinct improvement compared to EURO 3 is noticeable. Effect of reduction is distinctively better for larger particles, size range 200-400 nm than for smaller ones. This is in agreement with the model of agglomeration if concentration of primary particles is reduced. Large particles are determining particle mass, which is reduced by a factor of 5 from EURO 3. The overall view of EURO 4 and EURO 5 is quite similar.

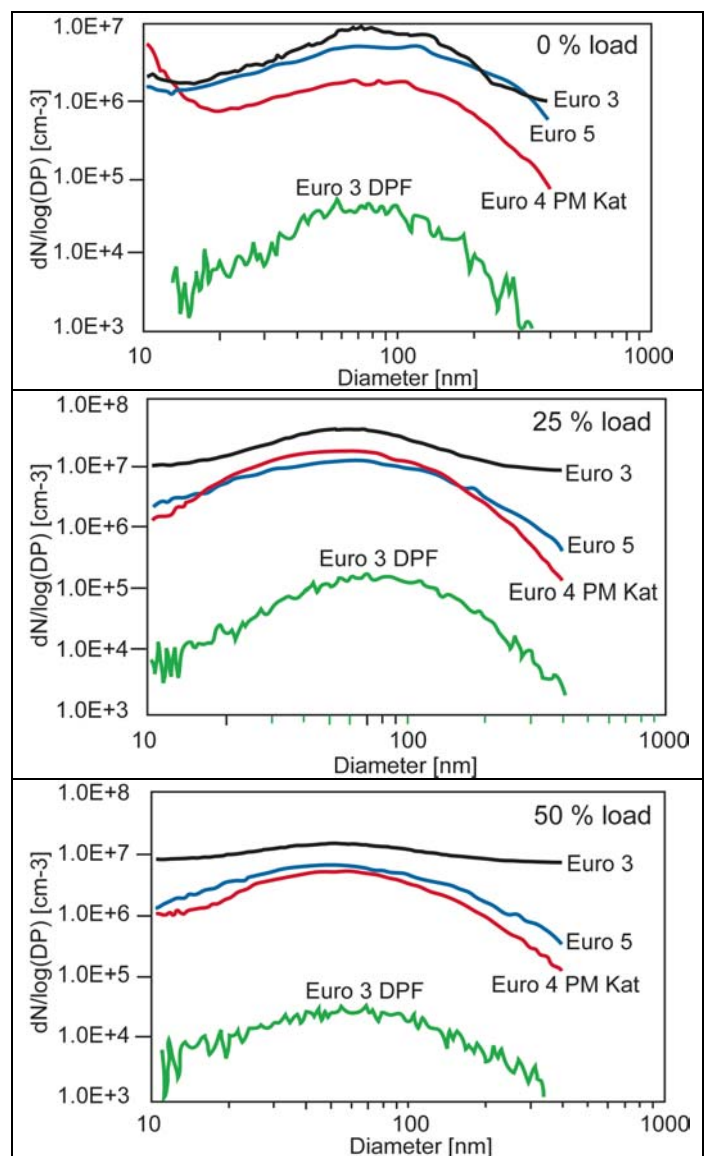

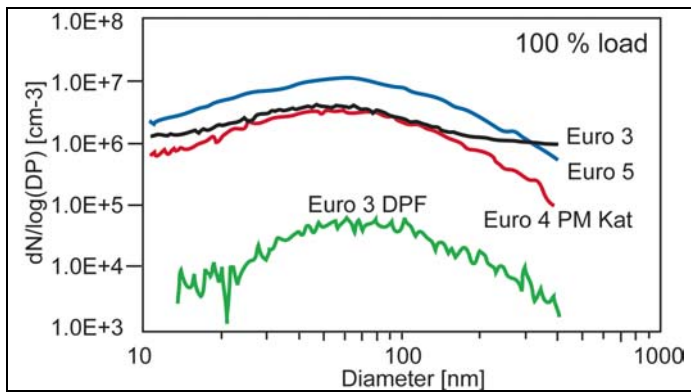

Fig. 3: Emissions of fine particles at load average, 1400 rpm

Two observations deserve attention:

- At full load EURO 5 emits more than EURO 3; obviously, the weight of this operating point contributes little to the result of the cycle test, hence it is acceptable for the certification procedure. On the other hand, in real world operation it occurs at each traffic light; therefore, some critique may be permitted.
- A poor behaviour of the PM-Kat at low loads is apparent in an increased penetration of very small solid particles.

Furthermore, it is apparent that applying a DPF conforming to VERT standard (1988) produces 2 to 3 powers of magnitude better results than the very latest HDV concepts.

Results for EURO 5 were reproducible while those of EURO 4 equipped with PM-Kat led to irritating observations at low loads, consequently partitioned. There was a rather large scattering of penetration ( $= 1 - \text{degree of separation}$ ) of the by-flow filter system for both, large and small particles; furthermore, at transition from zero load to 10% load occurred a complete breakdown of the filtering effect. Further increase of the engine-load brought a recovery of the system to retention rates of 30-50%; apparently the system had freed itself and had regained its capacity.

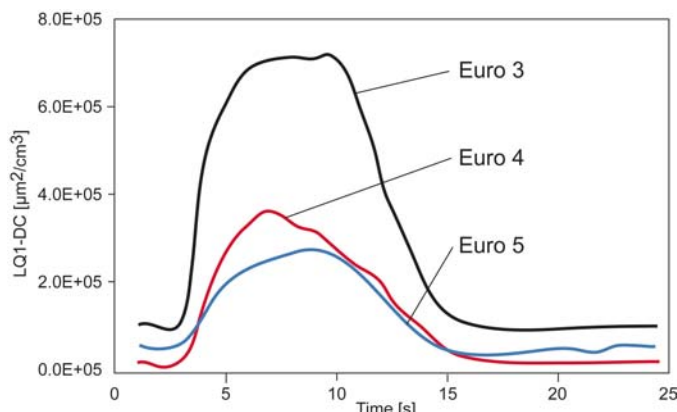

Fig.4: PM-Kat: Penetration at 1400 rpm, low load averages

Characteristics of retention are not reproducible in the range of low loads – dynamics of regeneration and antecedents influence filtration in unpredictable ways; it ought to be considered a problem of stochastic stability.

## Soot-Loading-Development of EURO 4-PM-Kat Systems

There is a strong influence of load development on the by-flow filter regarding separation quality. In the authors' opinion, further investigation of methodical variation of load developments avoiding regeneration deserved to be done.

A similar effect of volume-based filters (foam-filters, fibre-filters etc. is well known: long duration loading leads to a limiting case such that reaction pressure remains constant, incoming particle mass is almost the same as out-flowing, however, the size spectrum is shifted in favour of large particles – the effect of agglomeration [9,10]. The by-flow filter is likely different: Loading of the by-flow filter causes the main flow to increase; hence, one may expect that the degree of separation is continuously depleting until finally the complete breakdown occurs. On top of it, filter-cake, already formed on the by-flow, remains exposed to the main flow – there is some plausibility of a blow off-effect.

This effect may be explained best at zero-load: particle emission is low; however, the regenerating capacity is low too, because the catalyst's activation is negligible small – consequently, increasing load may be expected. Such operating conditions are not characteristic for the load profile of utility vehicles, nevertheless they are realistic and they ought to be considered from the viewpoint of "worst case".

At low rpm and zero-load, a just regenerated filter exhibits an average degree of separation of about 40%, albeit there is some distinct weakness in the range of small particles. At low rate loading it takes a few hours that the filter effect is decreasing towards zero separation. There is an increasing release of very small particles, up to even and more off-flow than on-flow. These emissions of ultra fine particles are frequently observed at low + rpm-zero load; they are metal-oxides of lube-oil additives due to increasing lube oil consumption and a weak blow-by effect.

It is also conceivable that there are many such ultra-fine particles just released from storage. Investigating at 1400 rpm and zero-load brought similar results for the trend, except that at the beginning the degree of separation of ultra-fine particles was extremely high (80%). Unfortunately, this rather positive quality changes with increasing load; loading was done in two steps of 2-4 hours – the characteristics of the filter topples over and finally a similar result is obtained as for low rpm +zero-load.

Similar observations with regard to load build-up have been published already [11, 12].

Degradation of filter effect is to be expected to an irreversible reduction of the by-flow ratio due to ash stemming from lubricants; hence, using lube oil of low ash content is highly recommended.



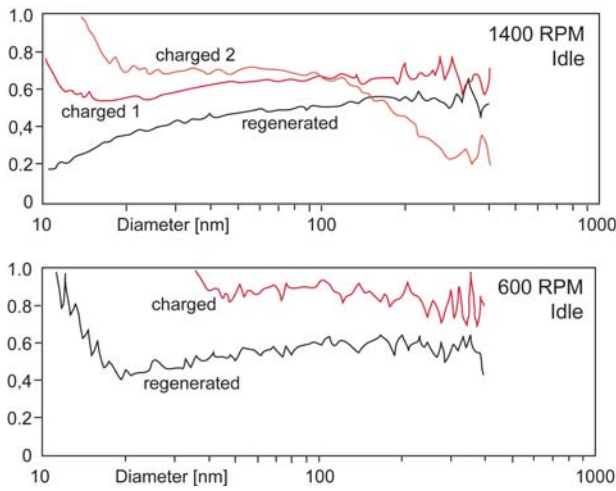

Fig. 5: Loading tests at both, low rpm zero-load and 1400 rpm zero load.

### Formation of volatile particles within the EURO 4-PM-Kat system

The following figures are thermographs of the exhaust prior and after the PM-Kat system: Influence of temperature at sampling on distribution of size was investigated.

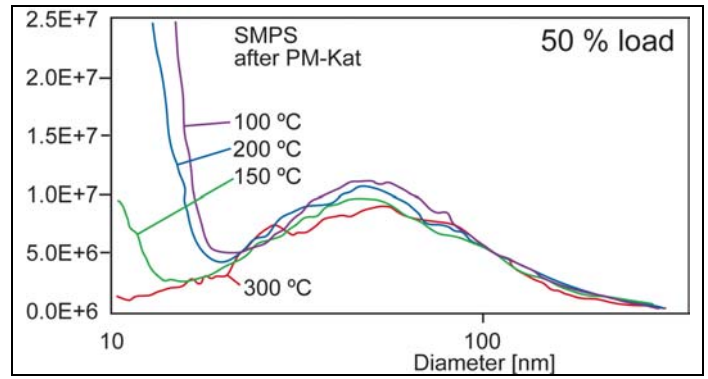
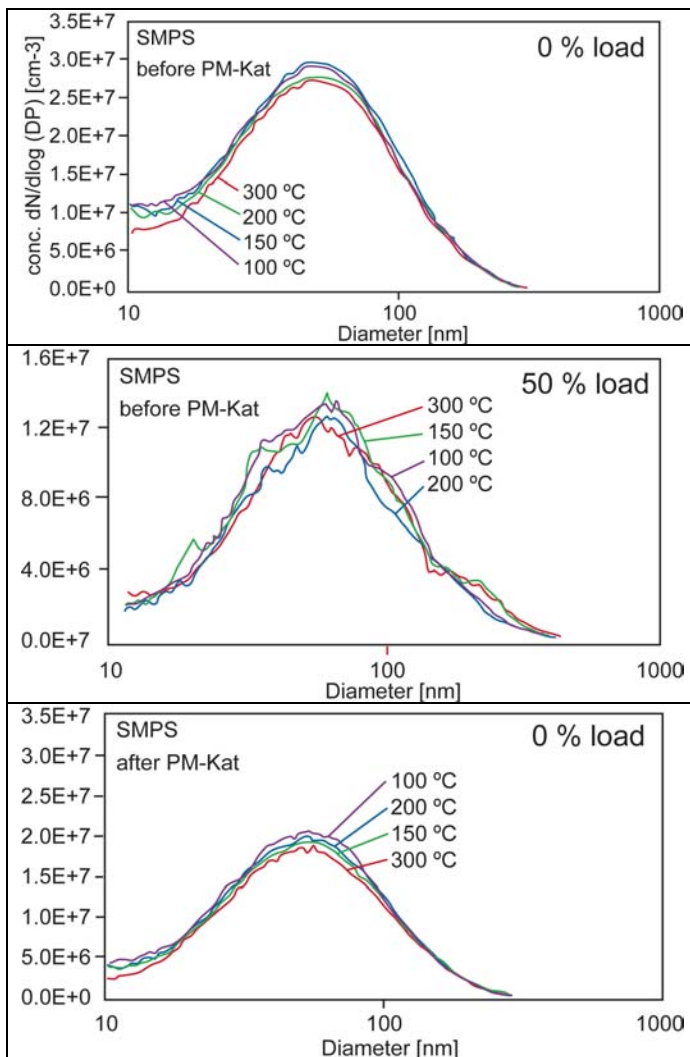

Fig. 6: Thermographs, sampling prior and after the PM-Kat at 1400 rpm, 2 different loads.

At zero-load sampling temperature apparently has no influence, while sampling temperature reducing at half-load is leading to an increasingly distinctive emission of very fine particles. Reason for this may be found in the activity of the catalyst: At low load there is no activity, at 50% load a substantial amount of sulphuric acid is formed, just another toxic component even as well undesirable for its corrosive effects.

### EURO 5-SCR: Peculiarities of emissions in stationary operation

Emissions of additional ultra-fine particles have been observed by various authors [13, 22]. Opportunity was grasped to investigate EURO 5 at all operating points with and without Ad-blue-injection. Some of the results are presented in the following figure 7 for the size range up to 100nm.

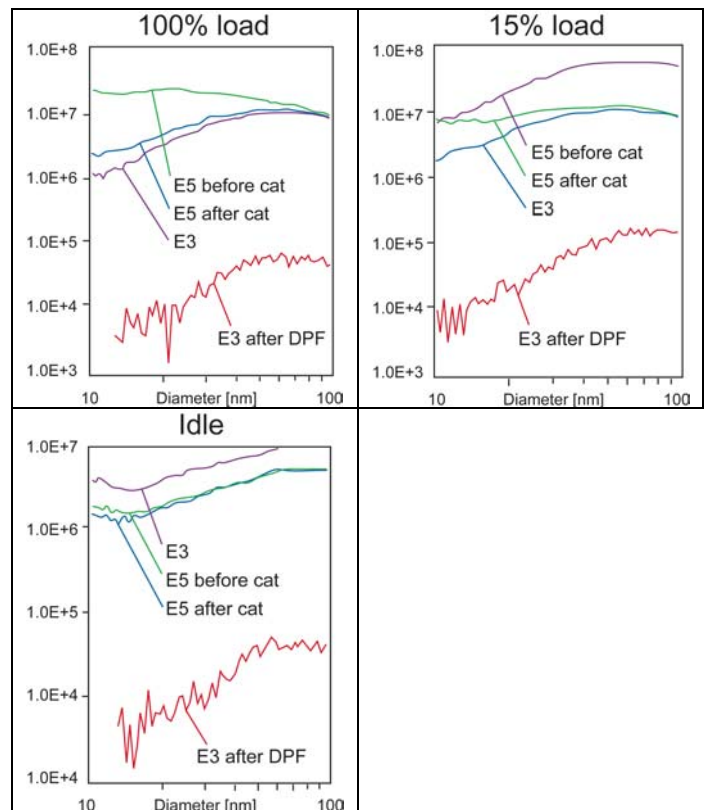

Fig. 7: Influence of Ad-blue injection on ultra-fine particle emission

In front of the catalyst there sure is a distinctive increase in emission of fine solid particles, even increasing with load leading at full load to some particle concentration higher than one power of ten in the size range below 30nm. Diffusion in the fine porous catalyst is only separating some fraction of these ultra-fine from the gas. At zero-load this phenomenon disappears and it is not observed when injection of Ad-blue is stopped. Ref [13] supposes formation of sulphates, while otherwise the authors of this paper are rather guessing in direction of not completely de-mineralised water; similar phenomena have been observed by the authors of ref. [20] in diesel-water emulsions where the effects could be verified definitively.

In the following conditions at free acceleration are presented: Starting from stable zero-load at low rpm, the accelerator-pedal is suddenly pushed down fully, i.e. the engine accelerates its internal mass to full load. This is a very critical case for smoke formation, which may exhibit the lag of the turbo-charger as well.

Obviously, automatic control of modern systems EURO 4 and of EURO 5 is much superior to EURO 3, peaks of acceleration are therefore much lower. However, the absolute level of the peak is in any case almost by one power of ten above the peak determined at full load and measured with the very same sensors.

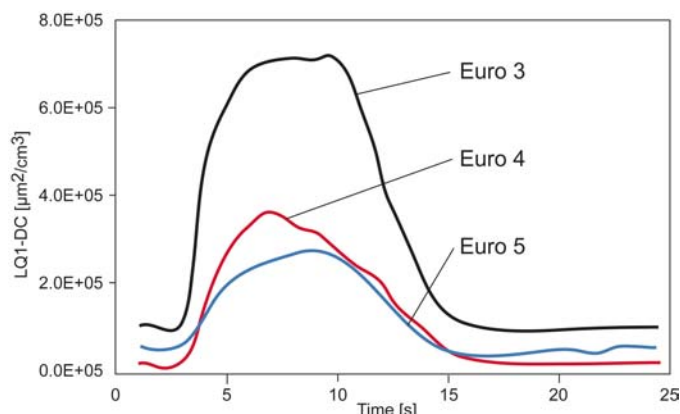

Fig. 8: Free accelerations, recorded with DC sensors of the NanoMet-system, averaged over 5 accelerations.

### Particle emissions in acceleration

Smoke of modern Diesel engines is that low, that classical methods based on opacity do not make sense any more. Sensitivity of modern particle sensors, in particular those two of NanoMet measuring systems PAS and DC is by two orders of magnitude superior to the classical method of opacity [21] and their dynamic response is sufficient to catch and record emission during drastic accelerations.

### Gaseous noxious emissions

Emissions of 4 principal components are presented. Operating points have been selected as to their respective importance, emissions shown are before and after the SCR-catalyst, Ad-blue injection on.

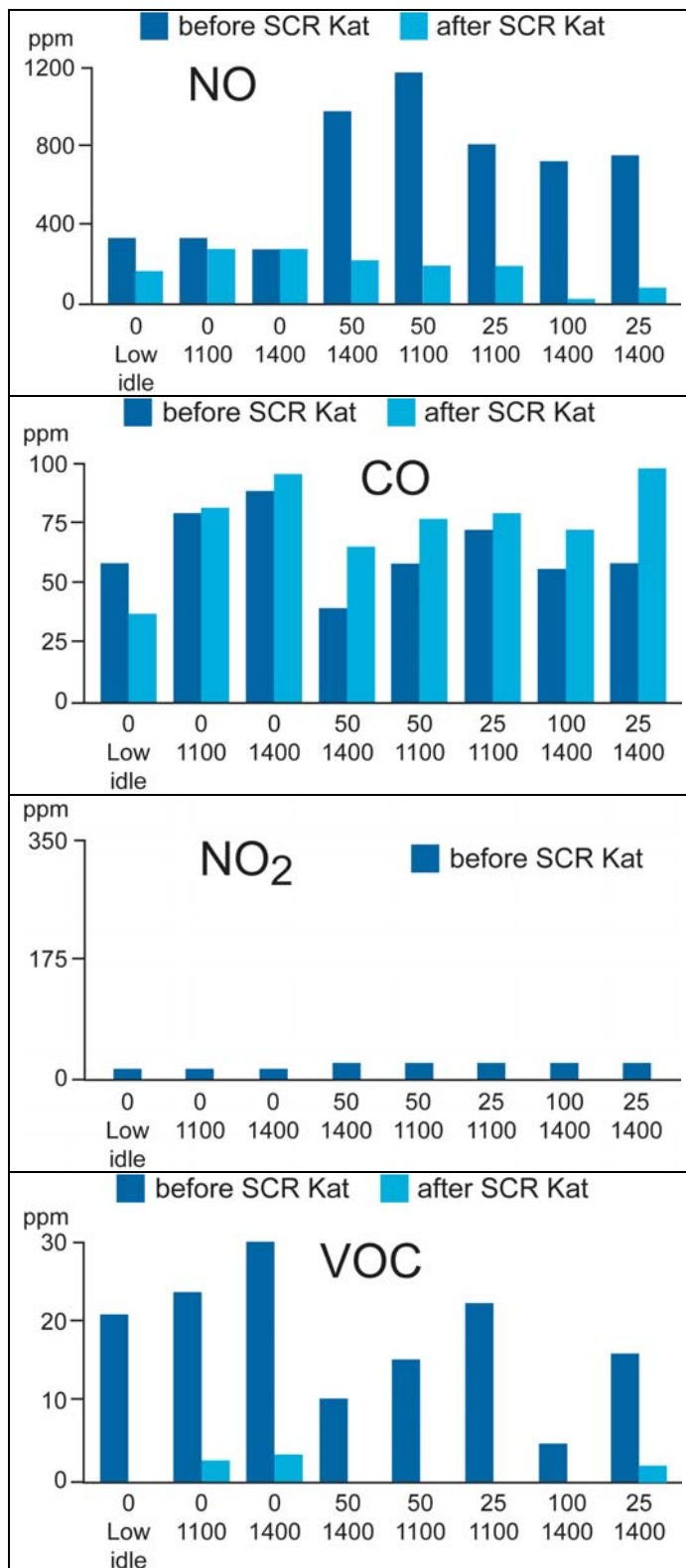

Fig. 9: Emissions of gaseous noxious substances stemming from EURO 5 vehicle

The SCR-DeNOx system is very efficient above 25% load. Under stationary conditions reduction of NOx was observed up to 98%. Only once a slight slip of ammonia was observed, otherwise concentration of ammonia was below detection limit of 20ppm. Concentration of N<sub>2</sub>O was below detection limit of 5 ppm. At zero-load there is no reduction of NOx, this latter fact should be seen critically in view of application for city busses. At any operating condition concentration of NO<sub>2</sub> is negligible; the latter result is ought to be reported delightfully in

view of exceeds at environmental measuring positions close to high volume traffic almost everywhere [14]. The SCR-catalyst reduces also hydrocarbons quite substantially, it does not contribute to reducing CO, which is well known [19]. It may just be remarked, modern diesel engine emit those two components far below limits anyway.

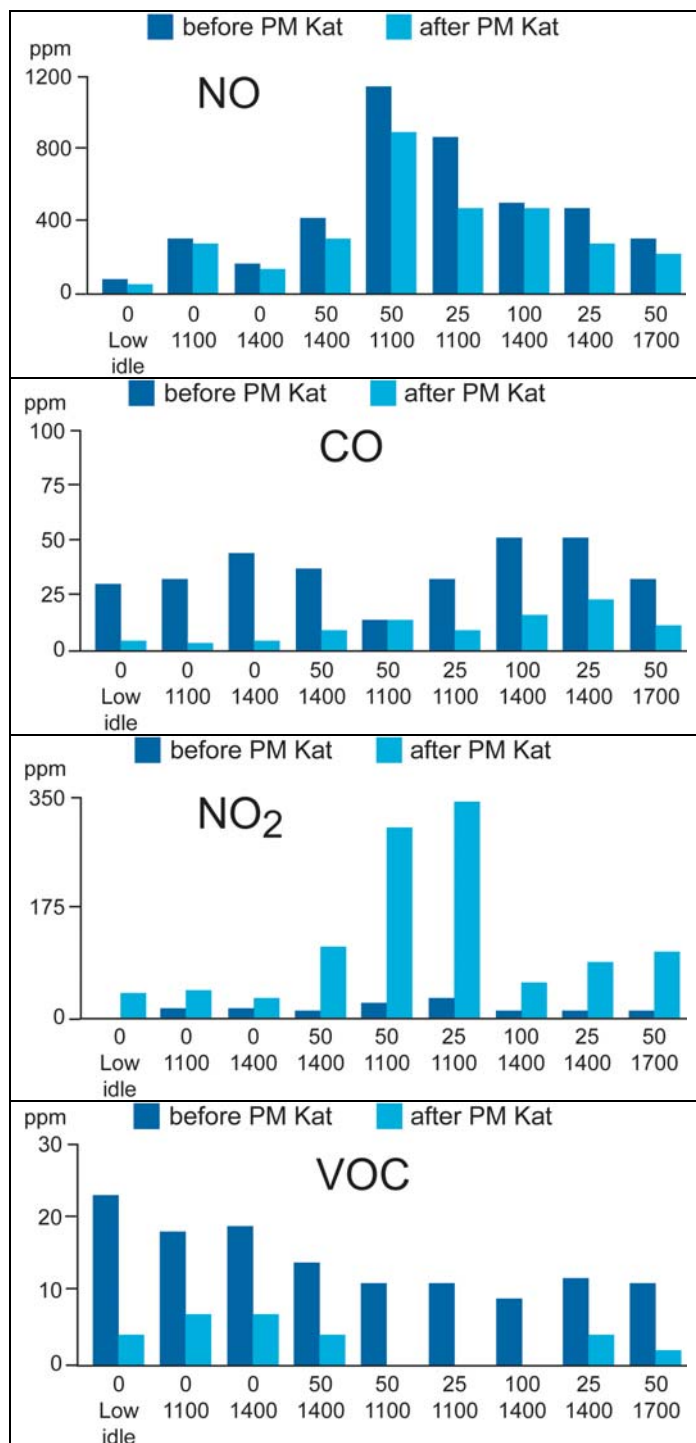

Fig. 10: Emissions of gaseous noxious substances of the EURO 4 vehicle

Usual response of Pt-coated oxidation catalyst, as is well known for CRT systems, is observed on EURO 4 [15]; CO and HC are efficiently decomposed their respective concentrations reach levels less than one magnitude of the limit. NO is efficiently transformed to NO<sub>2</sub> as soon as the exhaust temperature exceeds 240°C, the threshold of the catalyst. At higher temperatures conversion rate

goes down due to chemical equilibrium. Availability of NO<sub>2</sub> at higher than stoichiometric demand is necessary for reliable function of the system, which depends on continuous regeneration. However, there is high NO<sub>2</sub> slip, which may become a serious drawback in the near future, as there are exceeding NO<sub>2</sub> limits wide-spread [14].

### Emissions of metals

Average concentration of Vanadium in the exhaust gas was found to be 102ng/m<sup>3</sup>, clearly above concentration in ambient air of 0.8-2.4 ng/m<sup>3</sup> [16], but below the WHO terms of reference 1000ng/m<sup>3</sup>, which is regarded the threshold for health effects [26]. Emissions of platinum were below detection limit of 7ng/m<sup>3</sup>, which was remarkable low as modern three-way catalysts have been quoted up to 100 ng/m<sup>3</sup> [17].

### Evaluation of methods for particle measuring

This investigation was not aimed at comparing measuring instruments, methods have been selected for the following reasons:

SMPS a far spread method for a fine analysis of size distributions; the diffusion oriented mobility diameter is the reference -method. Draw back is seen in the limitation of the size range at maximum 400 nm upper limit; consequently agglomerates to be expected in open systems [9] cannot be observed. Furthermore, the SMPS is not suitable for transients.

NanoMet provides information regarding the total active surface (Fuchs surface) of the particles by means of two sensors PAS and DC. Range is below 1µm and on top of it there is some information on chemical composition. PAS signals correlate well with EC, both sensors are suitable for transients, even in free acceleration emissions of particles can be recorded.

PASS provides over the size-range an integrated value for total EC.

ELPI yields a rather broad classification of size ranging from about 30 nm to 10µm; it enables an on-line recording of the electric signal. ELPI and PASS have been applied for measuring the EURO 4 only.

PMP-sampling with heating of the sample to 300°C and subsequent dilution, which may be selected freely to several hundred times, separates reliably solid particles and volatile aerosols [15].

The **above** figure shows the degree of separation of a HJS sinter-metal DPF complying to VERT standard. Data of SMPS (number and mass), PAS and DC have been determined for 4 operating points. Most of them are at about 99.8%, at the highest volume-velocity degree of separation goes down to 99% straight. It ought to be remarked: this statement is valid as well for the number as well for the mass criterion according to SMPS and to EC (PAS-signal) and for the Fuchs-surface. The results of all the sensors and instruments are pretty well in agreement.

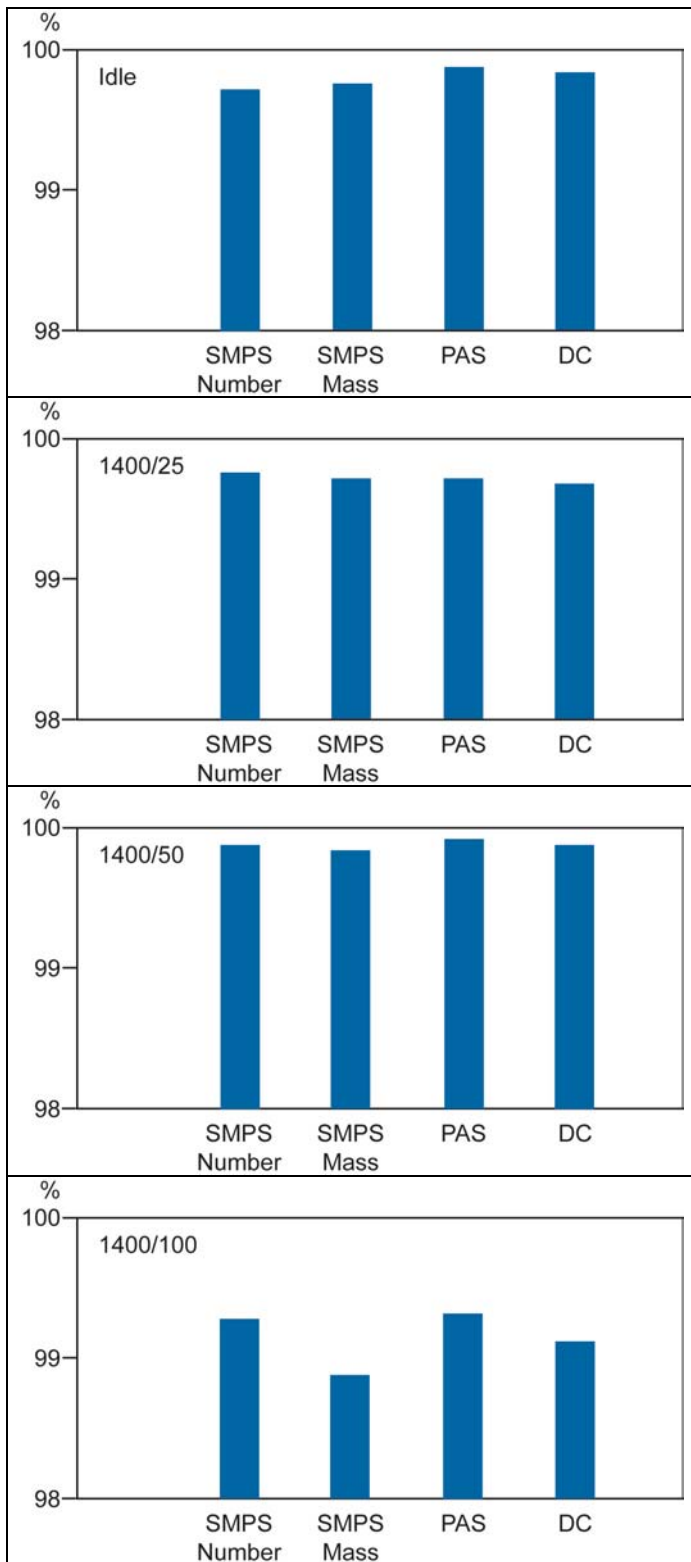

Fig. 11: Degree of separation of the retrofit DPF of the EURO 3 vehicle.

Several measuring systems have been used in that case, results are presented as penetration, because statements on blow off phenomena are feasible this way. At higher loads all five instruments yield quite uniform results, if continuous regeneration occurs and the ratio of bypass flow is about constant. At low loads is a rather wide scattering visible, frequently a total failure of separation – even measured by means of PAAS and ELPI, methods applicable for large particles too. Results do scatter not only between various measuring methods but

also reproducibility of the very same instruments is missing.

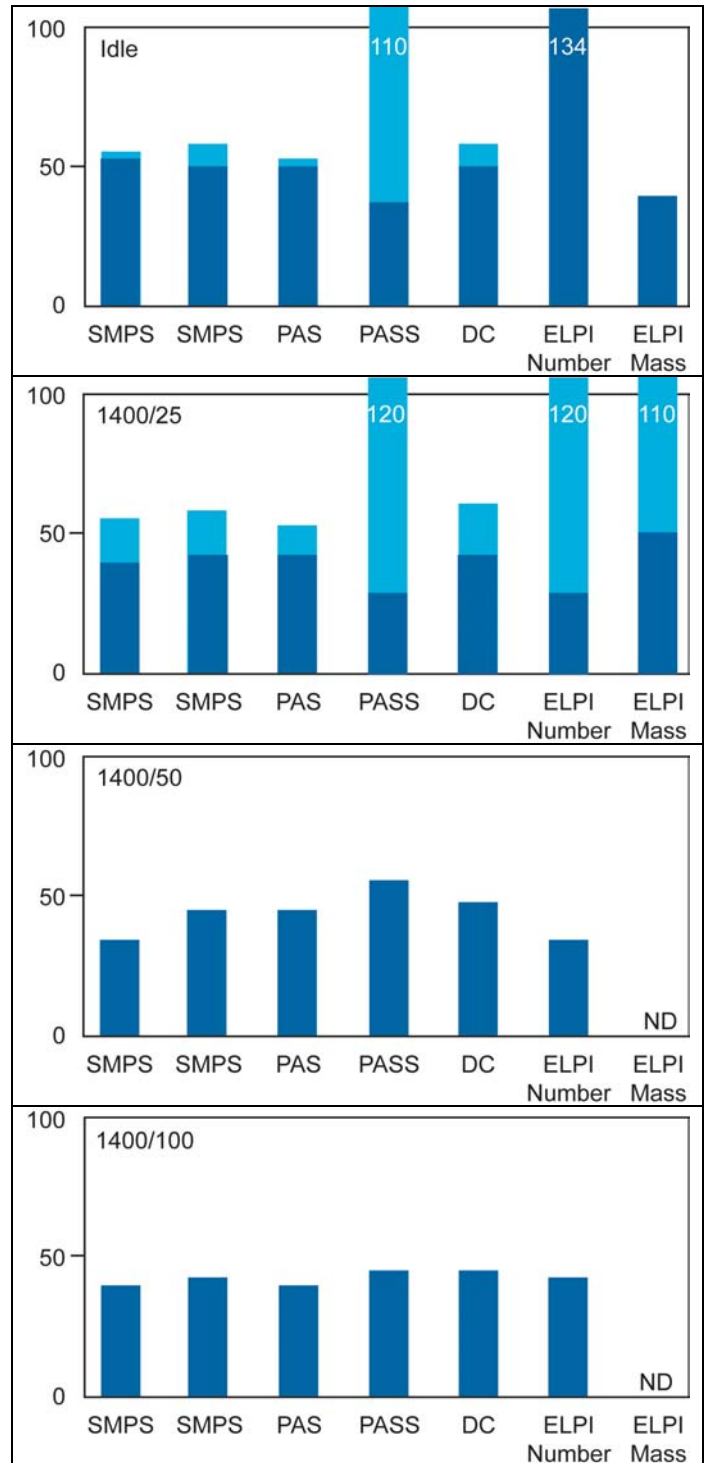

Fig. 12: EURO 4 vehicle: Penetration of the PM-Kat.

### Conclusions and outlook.

Investigations brought evidence, modern EURO 4 and EURO 5 vehicles release moderately less particles compared to EURO 3 at almost all operating conditions and over the whole size range, albeit the reduction of larger particles is better. A change of the mean particle size (mobility diameter) cannot be seen from these observations when considering transition from EURO 3 to EURO 4/5. Furthermore, it was found that particle-emissions of the EURO 5 SCR-concept are well reproducible as well



as EURO 3 with and without DPF. In contrast, EURO 4 with PM-Kat is unstable even in a stochastic sense: Several times it occurred for the same operating conditions that in one case 30-40% separation were observed, while repeating and starting to tune the operating point differently from another operating point lead to zero filter effect. Published evidence of filter-effect strongly depending on soot load and engine operating point is confirmed. Regarding long-time stability there are reservations due to catalyst aging and irreversible sticking-on of ash particles. De-nitrification of the SCR is impressive at minimal slip of ammonia, while in contrast the EURO 4 vehicle exhibits a substantial NO<sub>2</sub> slip; it is emitting at close to average operating conditions rather remarkable amounts of aerosols of sulphuric acid. Emissions of metals are small in both concepts, albeit experiments were not designed with regard to that question or to bring about worst case conditions.

Conclusion of our investigation is, that both concepts, EURO 4 and EURO 5 need improvement by means of particle filter complying to the state of the art, in order to compete successfully with EURO 3 standard retrofit with DPF regarding nano-particle emissions.

In the meantime, the EURO 5 system subject to this investigation has been brought onto the market with a DPF, complying VERT criteria, just up-flow to the SCR, which deserves to be commended at this stage.

## References

[1] PM and the Central Nervous System; Calderon, L / 10.ETH-conference on Combustion Generated Nanoparticles 8/2006

[2] Proceedings of the Pneumoconiosis Conference, Feb. 1959 Johannsburg  
A.J.Ohrenstein, J&A Churchill Ltd, 1960

[3] Schweizerische Luftreinhalteverordnung LRV1985

[4] Update on the PMP Light Duty Inter-Laboratory Correlation Exercise  
J.Anderson / 10.ETH-conference on Combustion Generated Nanoparticles 8/2006

[5] Secondary Emissions Risk Assessment of Diesel Particulate Traps for HDV Applications  
N.V-Heeb et al, SAE 2005-26-014

[6] VERT-Filterliste, SUVA / BAFU 2006;  
[www.umwelt-schweiz.ch/buwal/de](http://www.umwelt-schweiz.ch/buwal/de)

[7] Weisungen des Eidgenössischen Justiz- und Polizeidepartementes EJPD 8/1990

[8] VERT Particulate Trap Verification  
A.Mayer et al. , SAE 2002-01-0435

[9] The Influence of a Particle Trap on the Size Distributions of Diesel Particles, D.Kittelson,  
SAE 850009

[10] Pre-Turbo-Application of the Knitted Fiber Diesel Particulate Trap  
A.Mayer et al, SAE 94'459

[11] Meeting EU 5 PM emission Standards. Comparison of different Particulate Traps  
Zelenka, P.; ETH-Nanopartikelkonferenz 8/2006

[12] Metal supported particulate-matter-cat; a low impact and cost effective solution  
L.Pace et al ; SAE 2005-01-0471

[13] Particle Emissions from a HD Diesel Vehicle with Urea SCR Catalyst  
Y.Goto; NTSEL, 9.ETH-conference on Combustion Generated Nanoparticles 8/2005

[14] NO<sub>2</sub> – die neue Herausforderung ?  
J.Lemaire, W.Naschke; NO<sub>2</sub>-Workshop München 8.2.2006

[15] The Use of Continuously Regenerating Trap CRT to Control Particulate Emissions  
R.Allansson et al. ; SAE 2002-01-1271

[16] Chemical Characterization of PM2.5, PM10 and Coarse Particles  
Ch.Hueglin et al; Atmospheric Environment 39 , 2005, 637-651

[17] Forschungsverbund Edelmetall-Emissionen, Abschlussbericht GSF  
GSF-Forschungszentrum für Umwelt und Gesundheit; D.Pohl, München, 1997

[18] Fuel Effects on the Characteristics of Particle Emissions for Advanced Engines  
CONCAWE-Report Nr. 1/05.

[19] Off-Highway Exhaust Gas Aftertreatment combining Urea-SCR, DOC and DPF  
H.T.Hug, A.Mayer et al. , SAE 930363

[20] Influence of AQUAZOLE, a Water in Diesel Fuel Emulsion on Nanoparticle Emissions  
R.Tort, 4.ETH-conference on Combustion Generated Nanoparticles 8/2000

[21] Sampling and Measurement of Nanoparticle Emissions for Type Approval  
M.Kasper, SAE 2005-26-013

[22] Characterization of Nanoparticles from a 2010-Type heavy Duty Diesel Engine  
M.Khair et al ; 9.ETH-conference on Combustion Generated Nanoparticles 8/2005

[23] Emissionsmessungen an einem EURO 5 LKW am Rollenprüfstand der LARAG AG in Wil.  
Sekundäremissionen von Stickstoffverbindungen und Vanadium.  
J.Mohn, et al; EMPA-Prüfbericht 438'957

[24] Emissionsmessungen an einem EURO 4LKW mit PM-Kat. Sekundäremissionen von Stickstoffverbindungen und Platin.  
J.Mohn et al. ; EMPA-Prüfbericht 439'927

[25] Time-Resolved Ammonia Measurement in Vehicle Exhaust;  
J.Mohn et al.; Int. J. Environment and Pollution 22 3, 342-356

[26] WHO 2000, World Health Organization, Air Quality Guidelines

[27] Zahlenspiel-Number Play; F.J. Legerer and A.Mayer, Ö.IAZ, 150., 6/2005, p.230.